



HBN301.1S



en Instruction manual



BOSCH





Making cooking as much fun as eating

Please read this instruction manual. This will ensure that you make use of all the technical benefits the cooker has to offer.

It will provide you with important safety information. You will then be familiarised with the individual components of your new cooker. And we will show you how to make settings step by step. It is quite simple.

The tables list the settings and shelf positions for numerous well-known dishes. All these dishes are tested in our cooking studio.

In the unlikely event of a fault, look here for information on how to rectify minor faults yourself.

A detailed table of contents will help you to find your way around quickly.

Enjoy your meal!

Instruction manual

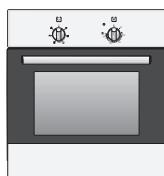

HBN 301.1S

en 9000446461

B-020489-01

Important information	6
Before installation	6
Safety information	6
Reasons for damage	8
Your new cooker	9
The control panel	9
Oven	10
Temperature selector	11
Oven and shelving accessories	12
Door lock	13
Cooling fan	13
Before using for the first time	14
Removing packaging material	14
Heating up the oven	15
Pre-cleaning the accessories	15
Setting the oven	16
Setting procedure	16
Rapid heating	17
Setting procedure	17
Care and cleaning	17
Cleaning agents	18
For easier cleaning	19
Cleaning the shelf frames	20
Troubleshooting	22
Replacing the oven light on the ceiling of the oven	22
After-sales service	23
Tables and tips	24
Cakes and pastries	24

Table of contents

Baking tips	26
Meat, poultry, fish	27
Tips for roasting and grilling	30
Bakes, gratins, toast	31
Frozen foods	31
Defrosting	32
Drying	32
Preserving	33
Energy saving tips	34
Acrylamide in foodstuffs	35
Test dishes	36

Important information

Read this instruction manual carefully. Only then will you be able to operate your appliance safely and correctly.

Please keep the instruction and installation manual in a safe place. Please pass on these instruction manuals to the new owner if you sell the appliance.

Before installation

Disposing in an environmentally-responsible manner



Unpack the appliance and dispose of the packaging in an environmentally-responsible manner.

This appliance is labelled in accordance with the European Directive 2002/96/EC concerning used electrical and electronic appliances (waste electrical and electronic equipment – WEEE).

The guideline determines the framework for the return and recycling of used appliances as applicable.

Transport damage

Check the appliance for damage after unpacking it. Do not connect the appliance if it has been damaged in transport.

Electrical connection

If the power cable is damaged, it must be replaced by a specialist trained by the manufacturer in order to prevent hazards.

Safety information

This appliance is intended only for domestic use. This appliance must only be used for food preparation.

Adults and children must not operate the appliance without supervision

- if they are physically or mentally incapable of doing so
- or if they lack the knowledge and experience required to operate the appliance correctly and safely.

Never let children play with the appliance.

Children



Children may prepare meals only if they have been properly instructed. They must be able to operate the appliance correctly. They must understand the hazards indicated in the instruction manual. Children must be supervised when using the appliance, to ensure that they do not play with it.

Hot oven



Open the oven door carefully. Hot steam may escape. Never touch the internal surfaces of the microwave oven or the heating elements. There is a risk of being burnt. Children must be kept at a safe distance from the appliance.

Never place combustible items in the oven. There is a risk of fire.

Never trap cables of electrical appliances in the hot oven door. The cable insulation could melt. There is a risk of short-circuiting.

Be careful with food that is prepared with drinks with a high alcohol content (e.g. cognac, rum).

Alcohol evaporates at high temperatures. In unfavourable circumstances, the alcoholic vapours could catch fire in the oven. There is a risk of burning.

Only use small quantities of drinks with a high alcohol content and open the oven door carefully.

Repairs



Incorrect repairs are dangerous. There is a risk of electrocution.

Repairs may only be carried out by one of our experienced after-sales engineers.

If the appliance is faulty, disconnect the fuse in the fuse box. Call the after-sales service.

Reasons for damage

Baking tray, aluminium foil or dishes on the oven floor

Do not place the baking tray on the oven floor. Do not cover it with aluminium foil.

Do not place dishes on the oven floor.

This will cause heat accumulation. The baking and roasting times will no longer be correct and the enamel will be damaged.

Water in the oven

Never pour water directly into a hot oven. This could damage the enamel.

Fruit juice

When baking very moist fruit cakes, do not put too much on the baking sheet. Fruit juice dripping from the baking sheet leaves stains that cannot be removed.

It is recommended that you use the deeper universal pan.

Cooling with the oven door open

Only leave the oven to cool with the door closed. Do not allow anything to become trapped in the oven door. Even if you only leave the oven door open slightly, the fronts of adjacent units may become damaged over time.

Very dirty oven seal

If the oven seal is very dirty, the oven door will no longer close properly when the oven is in use. The fronts of adjacent units could be damaged. Keep the oven seal clean.

Using the oven door as a seat

Do not stand or sit on the oven door.

Transporting the cooker

Do not hold or carry the cooker by the door handle. The door handle cannot hold the weight of the cooker and may break off.

Your new cooker

Here you will learn more about your new oven. The control panel and its switches and indicators are explained here. The heating modes and the accessories included with your oven will be explained here.

The control panel

Details vary according to the appliance model.

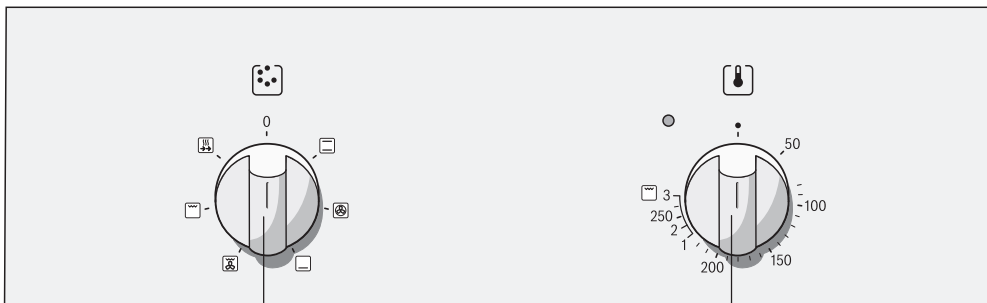

Function selector

Temperature selector

Oven

Function selector

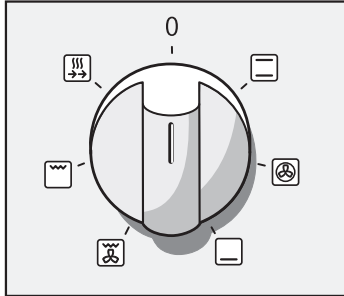

With the function selector knob you can set the heating mode for the oven.
The function selector knob can be rotated to the right or to the left.

The Positions

0	Off
Upper and Lower Heat	Baking, roasting or grilling is possible on a single level only. Cakes can be baked in a cake mould/tray, pizzas can be baked in a tray, lean beef, veal and game can be roasted in a roasting tray.
3D Hot air*	You can bake cakes, pizza, biscuits, muffins and puff pastry on two levels at the same time.
Lower heat	Use this for food items where a darker crusty bottom surface is required.
Hot air circulation assisted grilling	Can be used for grilling larger pieces of meat.
Large area grill	Can be used to grill a large number of beefsteaks, sausages, fish, and to toast bread.
Rapid heating	for heat up the oven quickly

*Heating mode with an energy efficiency rating specified by EN50304.

When the function selector knob is set the oven lighting is switched on.

Temperature selector

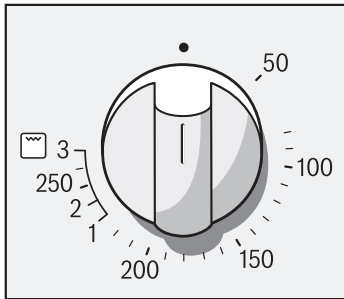

Use the temperature selector to set the temperature or grill setting.

Temperature	
50 - 270	Temperature range in °C
Grill	
1	Low grill
2	Medium grill
3	High grill

The indicator light by the temperature selector comes on while the oven is heating up. It goes out during pauses in heating. The light does not come on for grilling.

Grill settings

You can select a grill setting on the radiant grill using the temperature selector.

Oven and shelving accessories

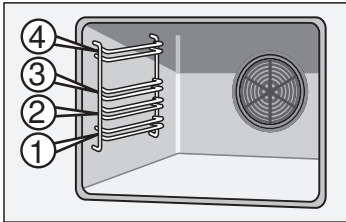

The shelf can be inserted at 4 different heights in the oven.

You can remove the shelf two thirds of the way without it tipping. This makes it easier to take food out of the oven.

Accessories

Accessories may be purchased at a later date from the after-sales service or from specialist shops. Please specify the HEZ number.

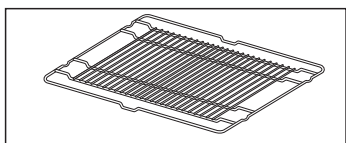

HEZ 434000 wire rack

for ovenware, cake tins, roasts, grilling and frozen meals. Insert the wire grill curving downwards .

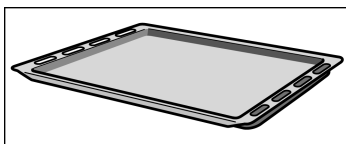

Enamel baking tray HEZ 431000

for cakes and biscuits.

Push the baking tray with the sloping edge facing towards the oven door.

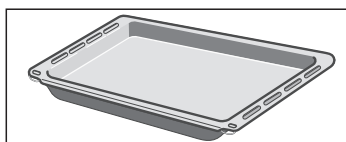

Universal pan HEZ 432000

for moist cakes, pastries, frozen food and large roasts. It can also be used to catch dripping fat when you are grilling directly on the wire grill.

Push the universal pan with the sloping edge facing towards the oven door.

Optional accessories*

Aluminium baking tray HEZ430000	For cakes and pastries.
Wire rack HEZ434000	For ovenware, cake tins, roasts, grilling and frozen meals.
Universal pan HEZ432000	For moist cakes, pastries, frozen meals and large roasts.
Enamel baking tray HEZ431000	For cakes and pastries.
Telescopic shelf x2 HEZ438200	With the pull-out rails at levels 1 and 3, you can pull the accessories out further without them tilting.
Telescopic shelf x3 HEZ438300	With the pull-out rails at levels 1, 2 and 3, you can pull the accessories out without them tilting.
Protective grid	The protective grid is fixed to the oven door. This prevents small children from touching the hot oven door. The protective grid can be ordered from the factory after-sales service with number 440651.

* You will find a comprehensive range of products for your cooker in our brochures and on the Internet. You can buy optional accessories from your local retailer.

Door lock

A door lock is enclosed with your oven. This is located underneath the control panel. Please observe the assembly instructions.

Press the door lock upwards to open. Make sure that the door engages when closing.

Cooling fan

The oven is fitted with a cooling fan. It switches itself on and off as necessary. The warm air escapes above the door.

Before using for the first time

This section will tell you everything you need to do before using the cooker for the first time.

Heat the oven and clean the accessories. Read the safety instructions in the “Important information” section.

Removing packaging material

You must remove the packaging material before using the oven for the first time.

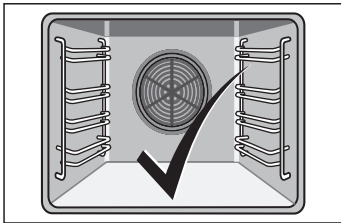

Packaging material such as polystyrene foam and cardboard will be found between the shelves and the oven casing, and in front of the back panel. Remove this.

Your oven is now ready for use.

Heating up the oven

Heat the empty oven with the door closed to remove the new oven smell.

Method

1. Set the function selector to .
2. Use the temperature selector to set the temperature to 240 °C.

Switch off the function selector after 60 minutes.

Pre-cleaning the accessories

Please wash the accessories thoroughly with soapy water and a cleaning cloth before using them.

Setting the oven

You can easily set the oven using the function selector and the temperature selector.

The correct type of heating and temperature for many dishes can be found in the Tables and tips section.

Setting procedure

Example:
Top/bottom heating , 200 °C

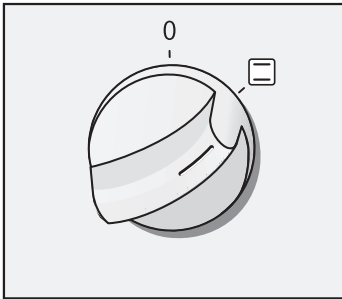

1. Select the desired type of heating using the function selector.

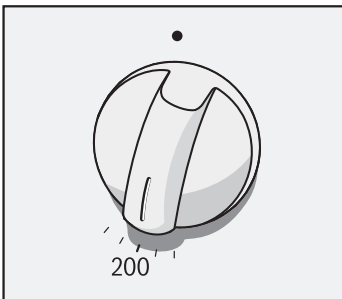

2. Use the temperature selector to set the temperature or grill setting.

Switching off

Switch off the function selector when the meal is ready.

Changing the setting

You may change the temperature or grill setting at any time.

Rapid heating

This allows you to heat up the oven particularly quickly.

Setting procedure

1. Switch the function selector to rapid heating .
2. Use the temperature selector to set the required temperature.

The oven switches on after a few seconds. The indicator light above the temperature selector will come on.

The rapid heating process is complete

The indicator light goes out.

Put your meal in the oven and set the oven.

Care and cleaning



Do not use high-pressure cleaners or steam jets. There is a danger of short-circuiting.

Do not use caustic or abrasive cleaning agents. The surface could be damaged. If an abrasive substance comes into contact with the frontage, wash it off immediately with water.

Cleaning agents

Appliance exterior:

Stainless steel surfaces

Clean with warm soapy water and a soft cloth. For stainless steel surfaces, always wipe in the direction of the grain so as not to scratch the surface. Dry with a soft cloth. Always remove any flecks of limescale, grease, starch and egg white immediately.

Harsh cleaning products, scratchy sponges and rough cleaning cloths are not suitable. Use a stainless steel cleaning agent for shiny surfaces. Please observe the manufacturer's instructions. Special stainless steel cleaning agents can be obtained from the after-sales service or from specialist shops.

Enamel surfaces and lacquered surfaces

Clean with warm soapy water and a dish cloth. Dry with a soft cloth.

Knobs

Clean with warm soapy water and a dish cloth. Dry with a soft cloth.

Door glass

Use glass cleaner. Do not use sharp or abrasive cleaning agents or a glass scraper. The glass could be damaged.

Seal

Clean with warm water and a cloth. Dry with a soft cloth.

Oven

Clean with warm soapy water and a dish cloth. Dry with a soft cloth.

For heavy soiling: only use oven cleaner in a cold oven.

Glass cover on the oven light

Clean with warm soapy water and a dish cloth. Dry with a soft cloth.

Accessories

Soak in hot soapy water. Clean with a brush or sponge.

Aluminium baking tray (optional)

Do not wash in the dishwasher. On no account use oven cleaner. The surface should not be touched with a knife or other similar sharp objects. Risk of scratching. Wipe the surfaces horizontally and without applying pressure with soapy water and a soft window cloth or a lint-free microfibre cloth. Dry with a soft cloth.

Harsh cleaning products, scratchy sponges and rough cleaning cloths are not suitable. They will scratch the baking tray.

Door lock (optional)

Remove the door lock for cleaning. Soak all plastic parts in hot soapy water and clean with a sponge. Dry with a soft cloth. If there is heavy soiling, the door lock may jam and no longer function.

Hob

Refer to the hob instruction manual for information about care and cleaning.

For easier cleaning

To switch on the oven lighting

For easier cleaning you can switch on the oven lighting, and remove the oven door.

Set the function selector to .

To remove the oven door

The removal of the oven door is quite simple.

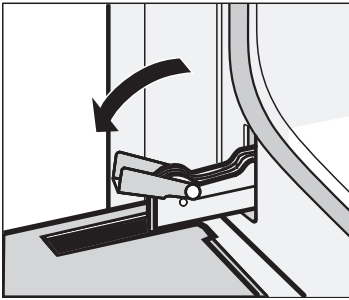

1. Open the oven door fully.
2. Swing open fully both the left and the right locking levers.

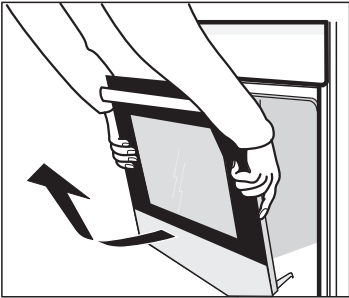

3. Hold the oven door from both the left and the right sides using both hands (ensuring that your hands are kept away from the hinges). Partly close the oven door (to a slanted position), pull forward and lift out.

After cleaning, re-assemble the oven door following the same procedure in reverse order.

Removing and installing the door panels

Removal

To facilitate cleaning, you can remove the glass panels from the oven door.

1. Detach the oven door and lay on a cloth with the handle facing down.
2. Unscrew the cover on top of the oven door. To do this, undo the right and left-hand screws (Fig. A).
3. Lift and pull out the upper panel (Fig. B).

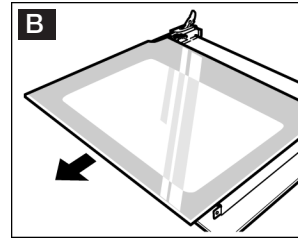
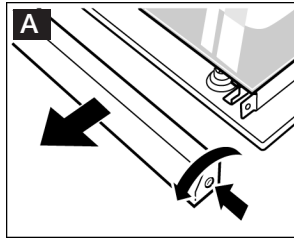

4. Unscrew the brackets on the right and left. Lift the panel and remove the brackets from the panel (Fig. C). Take out the panel.

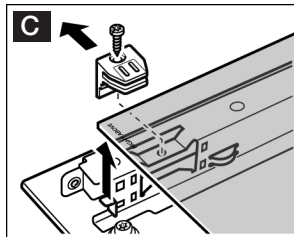

Clean the panels with glass cleaner and a soft cloth.

Do not use sharp or abrasive materials or a glass scraper. The glass could be damaged.

Installation

During installation, make sure that the lettering "right above" is upside down at the bottom left.

1. Insert the panel downwards at an angle (Fig. A).
2. Push on the brackets on the right and left, align them and screw in place (Fig. B).

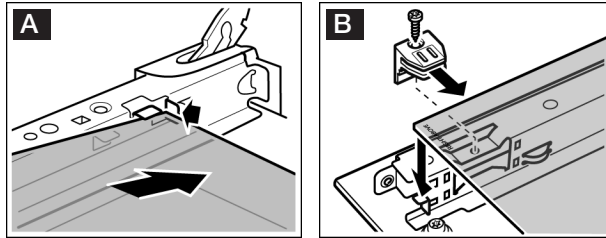

3. Insert the uppermost panel diagonally towards the back. The smooth surface must face outwards.
4. Replace the cover and screw in place.
5. Attach the oven door.

Do not use the oven again until the panels have been correctly fitted.

Cleaning the shelf frames

The shelf frames can be removed for cleaning.

To remove the shelf frames:

1. Hold the shelf frames from underneath and pull slightly forward. Pull out the projections at the bottom from the apertures they are inserted in.

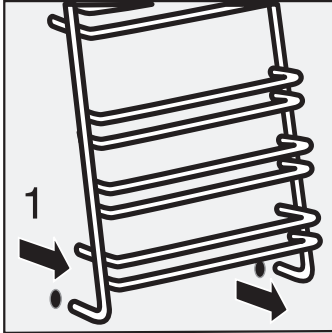

2. Then remove the complete frame by first pulling it downward and then forward.

Clean the shelf frames using washing-up liquid and a sponge or a brush.

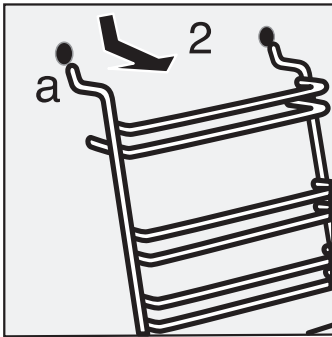

To hook rails back into position:

1. Insert the two hooks carefully into the upper holes.

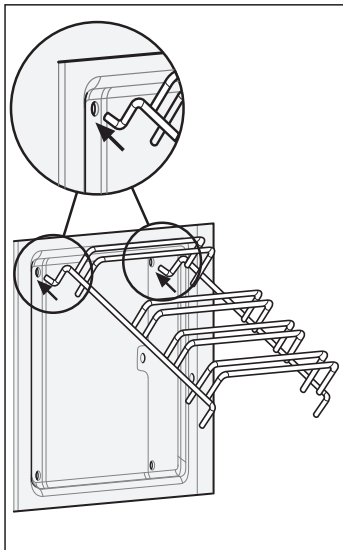

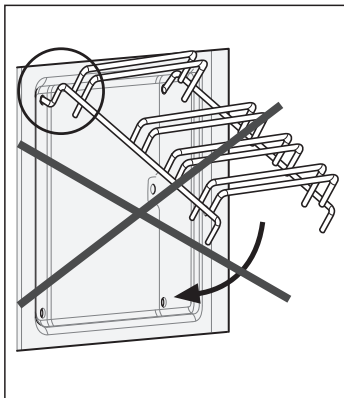

- **Caution. Incorrect assembly:** never move the rail before the two hooks are secured fully in the upper holes. The enamel can become damaged and break.

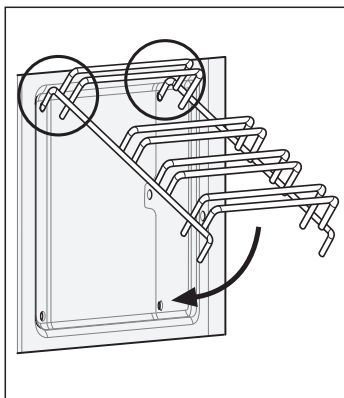

2. **Correct assembly:** the two hooks must be inserted fully into the upper holes. Now move down the rail slowly and carefully and insert into the lower holes.

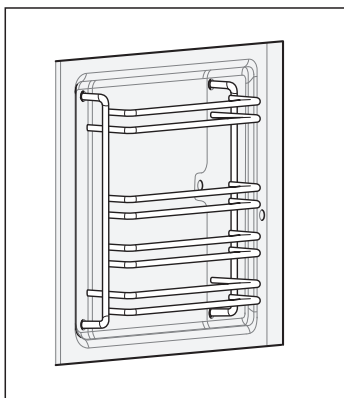

3. Insert both rails.
If the rails are fitted correctly, the distance between the two upper shelf positions is greater.

Troubleshooting

Should a malfunction occur, it is often only due to a minor fault. Please read the following instructions before calling the after-sales service:

Problem	Possible cause	Comments/remedy
The oven does not work.	Blown fuse.	Look in the fuse box and check that the fuse is in working order.
	Power cut	Check whether the kitchen light switches on.

Repairs may only be carried out by fully trained after-sales service technicians.

Improper repairs may constitute serious hazards to the user.

Replacing the oven light on the ceiling of the oven

If the oven light fails, it must be replaced. 25 watt heat-resistant replacement bulbs can be obtained from the after-sales service or specialist shops. Please specify the E number and FD number of your appliance. Only use these bulbs.

Method

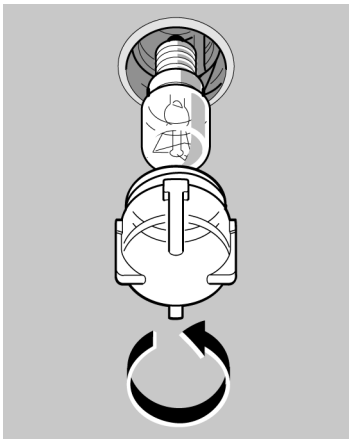

1. Switch off the oven fuse in the fuse box.
2. Place a tea towel in the cold oven to prevent damage.
3. Unscrew the lamp cover in the oven interior by turning it to the left.
4. Replace the bulb with one of the same type.
5. Screw the lamp cover back in.
6. Remove the tea towel and switch the fuse back on.

Replacing the glass cover

The glass cover on the oven light must be replaced if it is damaged. Replacement glass covers may be obtained from the after-sales service. To this end, please specify the E number and FD number of your appliance.

After-sales service

Our after-sales service is there for you if your oven needs repairing. You will find the address and telephone number of your nearest after-sales service centre in the phone book. The after-sales service centres listed will also be happy to advise you of a service point in your local area.

E number and FD number

Please quote the E number (product number) and the FD number (production number) of your appliance when contacting the after-sales service. The rating plate containing these numbers is found on the right, on the side of the oven door. You can make a note of these numbers in the space below to save time in the event of your appliance malfunctioning.

E no.	FD no.
-------	--------

After-sales service ☎

Tables and tips

This table contains a selection of dishes and the optimum settings at which to cook them. You can find out which type of heating and temperature is best for your dish, which accessories to use, and at which oven level the dish should be inserted. You will find a variety of tips about ovenware and preparation, and a small troubleshooting section in case anything should go wrong.

Cakes and pastries

Baking on one level

If you are baking cakes on one level, you should use top/bottom heating . This will give the best results for your cakes.

Baking tins

It is best to use dark-coloured baking tins made of metal. Baking times are increased when light-coloured baking tins made of thin metal or glass dishes are used, and cakes do not brown so evenly.

Place the cake tin on the wire rack.



Tables







The values in the table apply to dishes placed in a cold oven. This saves energy. Shorten the baking times indicated by 5 to 10 minutes if you have preheated the oven.

The tables show which type of heating is best for different cakes and bakes.











The temperature and cooking time you select depends on the quantity and type of pastry. This is why “ranges” are given in the tables. You should try to use a lower temperature setting to start with, since this allows more even browning. If necessary, use a higher temperature setting the next time.

More information can be found in the “Baking tips” section which follows the tables.



Cake in a mould	Cake mould placed on a wire shelf	Level	Heating mode	Temperature °C	Cooking time, minute
Simple cake mixture	Rectangular cake mould/tin	2		160-180	55-65
Stiff cake mixture (e.g. Fruit Cake)	Rectangular cake mould/tin	2		155-175	65-75

Cake in a mould	Cake mould placed on a wire shelf	Level	Heating mode	Temperature °C	Cooking time, minute
Cake base with sides made with stiff dough	Cake mould with a removable base	1		160-180	30-40
Cake base made of cake mixture	Fruit base mould	2		160-180	25-35
Sponge cake	Cake mould with a removable base	2		160-180	30-40
Cake with fruit or tart with with egg custard, tart pastry*	Dark coloured round mould with a removable base.	1		170-190	70-90
Cake with fruit made from stiff cake mixture	Cake mould with a removable base	2		150-170	55-65
Quiche/savoury tart* (e.g. quiche/onion tart)	Cake mould with a removable base	1		180-200	50-60









* Leave the cake in the appliance for approximately 20 minutes and wait for it to cool.

Cakes on trays		Level	Type of heating	Temperature °C	Baking time, mins
Cake mixture or yeast dough with dry topping	Universal pan	3		160-180	25-35
	Enamel baking tray + Universal pan*	1+3		150-170	40-50
Cake batter or yeast dough with moist topping (fruit)	Universal pan	3		140-160	40-50
	Enamel baking tray + Universal pan*	1+3		130-150	50-60
Swiss roll (preheat)	Universal pan	2		170-190	15-20
Plaited loaf with 500 g flour	Universal pan	2		160-180	25-35
Stollen with 500 g flour	Universal pan	3		160-180	50-60
Stollen with 1 kg flour	Universal pan	3		150-170	90-100
Strudel, sweet	Universal pan	2		180-200	55-65
Pizza	Universal pan	3		180-200	20-30
	Enamel baking tray + Universal pan*	1+3		150-170	35-45

* When baking on two levels, always place the universal pan above the baking tray.

Bread and rolls		Level	Type of heating	Temperature °C	Cooking time, mins
Yeast bread with 1.2 kg flour* (preheat)	Universal pan	2		270	8
				190	35-45
Sourdough bread with 1.2 kg flour* (preheat)	Universal pan	2		270	8
				190	35-45
Bread rolls (e.g. rye rolls) (preheat)	Universal pan	3		200-220	20-30



* Never pour water directly into a hot oven.

Small baked products		Level	Type of heating	Temperature °C	Baking time, mins
Biscuits	Universal pan	3		150-170	10-20
	Enamel baking tray + Universal pan*	1+3		130-150	30-40
Meringue	Universal pan	3		70-90	135-145
Cream puffs	Universal pan	2		200-220	30-40
Macaroons	Universal pan	3		110-130	30-40
	Enamel baking tray + Universal pan*	1+3		100-120	35-45
Puff pastry	Universal pan	3		190-210	20-30
	Enamel baking tray + Universal pan*	1+3		180-200	30-40

* When baking on two levels, always place the universal pan above the baking tray.

Baking tips

You wish to cook to your own recipe.	Refer to the instructions in the tables for similar types of food.
How to check that a sponge cake is cooked properly.	Approximately 10 minutes before the end of the baking time given in the recipe, pierce the tallest point of the cake with a cocktail stick. The cake is done if the cocktail stick comes out clean.
The cake collapses.	Next time, use less liquid or decrease the oven temperature by 10 degrees. Observe the cooking times in the recipe.
The cake has risen in the centre but is lower at the edges.	Do not grease the sides of the springform cake tin. As soon as the cake is done, carefully loosen the cake around the edges using a knife.
The cake is too dark at the top.	Insert it at a lower level in the oven, select a lower temperature and cook the cake a little while longer.

The cake is too dry.	Use a toothpick to make small holes in the finished cake. Then drizzle fruit juice or alcohol over the top. Next time you should decrease the temperature by around 10 degrees and reduce the baking times.
The bread or cake (e.g. cheesecake) looks fine, but is soggy on the inside (soft, with watery areas).	Next time you should add a little less liquid and cook for a little longer at a lower temperature. Cakes with fruit topping: Precook the base first of all. Sprinkle with almonds or breadcrumbs and then place the topping over this. Please observe the recipe and the baking times.
The pastry is unevenly browned.	Select a slightly lower temperature to ensure that the pastry is baked more evenly. Delicate pastry should be baked on one level using top/bottom heating  . Baking paper that protrudes over the food can affect the air circulation. For this reason, always cut the baking paper to fit the baking tray.
The fruit cake is too light at the bottom. The fruit juice flows over.	Use the deeper universal pan next time.
You were baking on several levels. The food on the top baking tray is darker than that on the bottom baking tray.	Always use 3D hot air  when baking on several levels. Baking trays that are placed in the oven at the same time will not necessarily be ready at the same time.
Condensation is formed when baking cakes containing fresh fruit.	Baking may result in the formation of water vapour. It escapes above the door handle. The steam may settle and form water droplets on the control panel or on the fronts of adjacent units. This is a normal physical process.

Meat, poultry, fish

Ovenware

You may use any heat-resistant dishes. The universal pan is also suitable for larger roasts.

Always place the dishes in the centre of the wire grill.

Hot glass dishes should be placed on a dry kitchen towel after being removed from the oven. The glass could crack if placed on a cold or wet surface.

Advice on roasting

The roasting result depends on the type and quality of meat.

Add 2 to 3 soup spoons of liquid to lean meat, and 8 to 10 soup spoons of liquid to pot roasts, depending on the size.

Meat should be turned half way through the cooking time.

When the roast is ready, switch off the oven and leave the roast to stand for 10 minutes with the oven door closed. This allows the meat juices to distribute more favourably.

Advice on grilling

Always close the oven door when grilling.

If possible, use pieces of meat which are of the same thickness. They should be at least 2 to 3 cm thick. Such pieces will be browned evenly and stay juicy and soft in the middle. Only salt the steaks after they have been grilled.

Place the pieces of meat directly onto the wire grill. If you are grilling just one piece of meat, it will turn out best if you place it in the centre of the wire grill.



















You should also insert the universal pan at level 1. The meat juices are collected here and the oven is kept clean.



Turn the pieces of meat after two thirds of the cooking time indicated.

The grill element automatically switches itself off and back on again. This is normal. The number of times this happens depends on the grill setting you have selected.

Meat

The table applies to insertion into a cold oven. The time specifications are provided as guidelines only and depend on the type and quality of the meat.

Meat	Weight	Ovenware	Level	Type of heating	Temperature °C, grill	Cooking time, mins
Pot-roasted beef (e.g. prime ribs)	1 kg	Covered	2		200-220	120
	1.5 kg		2		190-210	140
	2 kg		2		180-200	160
Sirloin of beef	1 kg	Uncovered	1		210-230	70
	1.5 kg		1		200-220	80
	2 kg		1		190-210	90
Roast beef, medium rare*	1 kg	Uncovered	1		230-250	50
Steaks, well done		Wire rack***	4		3	20
Steaks, medium rare		Wire rack***	4		3	15
Boned pork without rind (e.g. neck)	1 kg	Uncovered	1		190-210	120
	1.5 kg		1		180-200	150
	2 kg		1		170-190	170
Boned pork with rind** (e.g. shoulder, knuckle)	1 kg	Uncovered	1		190-210	130
	1.5 kg		1		180-200	160
	2 kg		1		170-190	190
Smoked pork on the bone	1 kg	Covered	1		210-230	80
Meat loaf	750 g	Uncovered	1		180-200	80
Sausage	Approximately 750 g	Wire rack***	4		3	15

Meat	Weight	Ovenware	Level	Type of heating	Temperature °C, grill	Cooking time, mins
Roast veal	1 kg	Uncovered	1		200-220	100
	2 kg		1		180-200	140
Boned leg of lamb	1.5 kg	Uncovered	1		170-190	120

* Turn roast beef halfway through the cooking time. After cooking, wrap the roast beef in aluminium foil and leave to stand in the oven for 10 minutes.

** Make cuts in the pork rind and if it is to be turned, place it with the rind down in the dish.

*** Insert the universal pan at level 1.

Poultry

The values in the table apply to dishes placed in a cold oven.







The weights indicated in the table are for unstuffed poultry that is ready for roasting.

If you are grilling directly on the wire rack, you should also insert the universal pan at level 1.

When cooking duck or goose, pierce the skin on the underside of the wings to allow the fat to escape.





Turn whole poultry after two thirds of the time.

Poultry will turn out particularly crispy and brown if you baste it towards the end of the roasting time with butter, salted water or orange juice.

Poultry	Weight	Ovenware	Level	Type of heating	Temperature °C	Cooking time, mins
Chicken halves, 1 to 4	Each 400 g	Wire rack	2		210-230	40-50
Chicken pieces	Each 250 g	Wire rack	3		210-230	30-40
Whole chickens, 1 to 4	Each 1 kg	Wire rack	2		200-220	55-85
Duck	1.7 kg	Wire rack	2		170-190	80-100
Goose	3 kg	Wire rack	2		160-180	110-130
Small turkey	3 kg	Wire rack	2		180-200	80-100
2 turkey drumsticks	Each 800 g	Wire rack	2		180-200	80-100

Fish

The values in the table apply to dishes placed in a cold oven.

Fish	Weight	Ovenware	Level	Type of heating	Temperature °C, grill	Cooking time, mins
Fish, grilled	Each 300 g	Wire rack*	3		Level 2	20-25
	1 kg		2		190-210	40-50
	1.5 kg		2		180-200	60-70
Fish, in slices (e.g. steaks)	Each 300 g	Wire rack*	4		Level 2	20-25

* Also insert the universal pan at level 1.

Tips for roasting and grilling

The table does not contain specifications for the weight of the roast.

Select the next lowest weight from the instructions and extend the time.

How can you tell when the roast is ready.

Use a meat thermometer (available from specialist stores) or implement a "spoon test". Press a spoon onto the roast. If it feels firm, it is ready. If it can be pressed in, it needs to be cooked for a little longer.

The roast is too dark and the crackling is partly burnt.

Check the insertion level and temperature.

The roast looks good, but the sauce is burnt.

Next time, use a smaller roasting dish and add more liquid.

The roast looks good, but the sauce is too light and watery.





Next time, use a larger roasting dish and add less liquid.

Steam rises from the roast when the stock is added.

Most escapes through the steam outlet, some may condense on the cool control panel front or the surrounding cabinets where it will drip off. This will be dependent on the physical conditions.

Bakes, gratins, toast

The values in the table apply to dishes placed in a cold oven.

Dish	Ovenware	Level	Type of heating	Temperature °C, grill setting	Cooking time, mins	
Sweet bake (e.g. quark soufflé with fruit)	Ovenproof dish	2		170-190	50-60	
Savoury bakes made from cooked ingredients (e.g. pasta bake)	Ovenproof dish	2		210-230	25-35	
Savoury bakes made from raw ingredients* (e.g. potato gratin)	Ovenproof dish	2		150-170	50-60	
Toasting bread	12 slices	Grill	4		3	4-5
Grilling bread	12 slices	Grill**	3		3	5-8





* The bake must be a maximum of 2 cm high.

** Also insert the universal pan at level 1.

Frozen foods

Please observe the instructions on the packaging.

The values in the table apply to dishes placed in a cold oven.

Meal		Level	Type of heating	Temperature in °C	Cooking time in minutes
Fruit strudel*	Universal pan	3		190-210	45-55
French fries*	Universal pan	3		210-230	25-30
Pizza*	Wire grill	2		200-220	15-20
Pizza baguette*	Wire grill	2		190-210	15-20

* Line the accessories with greaseproof paper. Please ensure that the greaseproof paper is suitable for use at these temperatures.

Note

The universal pan may become warped when baking frozen foods. This is caused by the considerable temperature fluctuations which affect the accessories. This warping is eliminated during the baking process.

Defrosting

Remove the food from its packaging and place it in a suitable dish on the wire grill.

Please observe the instructions on the packaging.

The defrosting times depend on the type and amount of food.

Meal	Accessories	Level	Type of heating	Temperature in °C
Frozen foods* e.g. cream gateaux, cream cakes, cakes with chocolate or icing, fruit, chicken, sausages and meat, bread, rolls, pastries and other baked goods	Wire rack	2	☉	The temperature selector remains switched off
* Place poultry onto the plate with the breast side down.				

Drying

Only use perfectly fresh fruit and vegetables, and wash them thoroughly.

Allow the food to drain well and dry it yourself.

Line the universal pan and wire rack with baking paper or greaseproof paper.

Meal	Level	Type of heating	Temperature in °C	Cooking time in hours
600 g apple rings	1 + 3	☉	80	Approx. 5
800 g sliced pears	1 + 3	☉	80	Approx. 8
1.5 kg prunes or plums	1 + 3	☉	80	Approx. 8 - 10
200 g fresh herbs, washed	1 + 3	☉	80	Approx. 1½

Note

Very moist fruit or vegetables should be turned several times. Once dried, remove the food from the paper immediately.

Preserving

Preparation

The jars and rubber sealing rings must be clean and intact. Use jars of the same size if possible. The instructions in the table refer to round 1-litre jars.

Caution Do not use larger or taller jars. The lid could crack.

Only use perfectly fresh fruit and vegetables. Wash them thoroughly.

Pour the fruit or vegetables into the jars. Wipe clean the tops of the jars again if necessary. They must be clean. Place a wet rubber sealing ring and lid on each jar and lock the jars using clamps.

Do not place more than six jars in the oven.

The times specified in the tables are guidelines only. They can be influenced by the room temperature, the number of jars and the amount and temperature of the jar contents. Before you change settings or switch off the appliance, make sure that the contents of the jars are actually bubbling.

Setting procedure

1. Place the universal pan on level 2. Place the jars inside the pan so that they do not come into contact with each other.
2. Pour ½ litre of hot water (approx. 80 °C) into the universal pan.
3. Close the oven door.
4. Switch the function selector to .
5. Set the temperature selector to 170 to 180 °C.

Preserving fruit

As soon as the contents of the jars begins to simmer, that is when small bubbles appear at short intervals - after about 40 to 50 minutes - turn off the temperature selector. The function selector remains switched on.

The jars should be removed from the oven after being reheated for 25 to 35 minutes. If the food is left to cool in the oven for longer, bacteria might form, causing the preserved fruit to spoil prematurely. Switch off the function selector.

Fruit in 1-litre jars	After bubbling	Reheating
Apples, red/blackcurrants, strawberries	turn off	approx. 25 minutes
Cherries, apricots, peaches, gooseberries	turn off	approx. 30 minutes
Apple purée, pears, plums	turn off	approx. 35 minutes

Preserving vegetables

As soon as the contents of the jars begins to simmer, set the temperature selector back to approximately 120 to 140 °C. The table shows when you can switch off the temperature selector. Allow the vegetables to stand in the oven for a further 30 to 35 minutes. The function selector remains switched on during this time.

Vegetables with cold stock in 1-litre jars	After bubbling 120 - 140 °C	Reheating
Cucumbers	–	approx. 35 minutes
Beetroot	approx. 35 minutes	approx. 30 minutes
Brussel sprouts	approx. 45 minutes	approx. 30 minutes
Beans, kohlrabi, red cabbage	approx. 60 minutes	approx. 30 minutes
Peas	approx. 70 minutes	approx. 30 minutes

Remove the jars

Never place the hot jars on a cold or wet surface as this could cause the glass to crack.

Energy saving tips

Only preheat the oven if it specifies in the recipe or in the table in the instruction manual that you should do so.

Use non-stick, black painted or enamelled tins. They absorb the heat especially well.

If you have several cakes to bake it is best to bake them one after the other. The oven is still warm. This shortens the baking time for the second cake. You can also put two baking tins in one after the other.

For long cooking times, the oven can be switched off 10 minutes before the end of the cooking time and the remaining heat can be used to finish the cooking.

Acrylamide in foodstuffs

Which foods are affected? Acrylamide is mainly produced in grain and potato products heated at high temperatures, such as potato crisps, chips, toast, rolls, bread, baked goods (biscuits, gingerbread, cookies).









Tips for keeping acrylamide to a minimum when preparing food	
General	Keep cooking times to a minimum. Cook meals until they are golden brown, not too dark. Large, thick pieces of food contain less acrylamide.
Baking	With top/bottom heating, maximum 200 °C, with 3D hot air or hot air, maximum 180 °C.
Biscuits	With top/bottom heating, maximum 190 °C, with 3D hot air or hot air, maximum 170 °C. Egg white and egg yolk reduce the formation of acrylamide.
Oven chips	Spread out a single layer evenly on the baking tray. Bake at least 400 g per baking tray so that the chips do not dry out.

Test dishes

In accordance with DIN 44547 and EN 60350 standard

Cakes and pastries

The values in the table apply to dishes placed in a cold oven.

Dish	Accessories and notes	Level	Type of heating	Temperature °C	Baking time, mins
Viennese whirls	Universal pan	3		150-170	20-30
	Enamel baking tray + Universal pan*	1+3		140-160	35-45
Small cakes 20 cakes	Universal pan	3		150-170	25-35
Small cakes, 20 per baking tray (preheating)	Enamel baking tray + Universal pan*	1+3		150-170	25-35
Hot water sponge cake	Springform cake tin	2		160-180	30-40
Yeast cakes on a baking tray	Universal pan	3		140-160	40-50
	Enamel baking tray + Universal pan*	1+3		130-150	50-60
German apple pie	Universal pan + 2 springform cake tins diameter 20 cm***	1		190-210	70-80
German apple pie	2 wire racks** + 2 springform cake tins diameter 20 cm***	1+3		170-190	65-75



* When baking on two levels, always place the universal pan above the baking tray.

** Additional baking trays and wire racks can be obtained as an optional accessory from specialist shops.

*** Place the cake tins diagonally on the accessories.

Grill

The values in the table apply to dishes placed in a cold oven.

Dish	Accessories	Level	Type of heating	Grill setting	Cooking time, mins
Toasting bread (preheat for 10 minutes)	Wire rack	4		3	1-2
Beefburgers, 12 pieces*	Wire rack	4		3	25-30

* Turn after $\frac{2}{3}$ of the time. Slide the universal pan in at level 1.



ROBERT BOSCH HAUSGERÄTE GMBH

Carl-Wery-Straße 34

81739 München

DEUTSCHLAND

9000446461

BO • en • 020489-01